

OCULUS
Pentacam®/
Pentacam® HR
Anterior Segment
Tomography



OCULUS Pentacam®/Pentacam® HR

The gold standard for anterior segment tomography



Since its introduction in 2002 the OCULUS Pentacam® has proven to be an indispensable tool for ophthalmologists, clinicians and surgeons committed to providing precise diagnostics and successful treatment.

Efficient preliminary and follow-up examinations

In a single delegable step the OCULUS Pentacam® measures the entire anterior eye segment independent of tear film. From the high-resolution Scheimpflug images it calculates a motion-corrected 3D model.

Comprehensive analysis

As the basis for precise keratometry, a prerequisite for IOL calculation, and for detection of ectasia and irregularities as well as wavefront calculation, the Pentacam® provides a complete description of the entire cornea (pachymetry as well as elevation and curvature data).

Scientifically reliable screenings

To perform quick and reliable glaucoma screenings the OCULUS Pentacam® determines anterior chamber volume, angle and depth automatically and then compares the values in the Fast Screening Report with a normal and a pathological population.

Reliable values for your diagnoses

Using blue light, the OCULUS Pentacam® makes opacities of the cornea, the crystalline lens and IOLs visible so that corneal diseases are detected reliably and cataract progression can be assessed objectively.

The Pentacam® HR stands out by virtue of its bright optics, which make for extremely sharp, highest-quality Scheimpflug images.

Testimonials of satisfied international Pentacam® users

"I cannot imagine any cornea or refractive surgery without a pre and post-op Pentacam® examination."

Dr. Paolo Vinciguerra, MD, Italy



"I have been using the Pentacam® since its inception. I could not imagine taking a refractive patient into surgery without a full tomographic examination. It is the single most important piece of diagnostic equipment in our laser suite. I consider it an indispensable part of my practice."

Dr. Michael W. Belin, MD, USA



"Since the first day I found the Pentacam® to be very reliable and essential for screening refractive candidates for ectasia risk. The Pentacam® is also very important for evaluating patients for corneal diseases, cataract and glaucoma."

Dr. Renato Ambrósio Jr, MD, PhD, Brazil



"In my opinion, the Pentacam® HR is a very useful device for screening before cataract surgery especially for premium IOLs. A detailed assessment can be performed to select the optimal IOL for the respective patient. Especially for toric IOL implantation, the influence of the posterior cornea can be assessed with the Pentacam®."

Dr. Naoyuki Maeda, MD, Japan



"Curvature measurement precision with Pentacam® HR has proved to be better than other tomographers and autokeratometers."

Dr. Jaime Aramberri, MD, Spain



*"The Pentacam® is a must for anyone performing cataract or refractive surgery. No other instrument provides more clinically relevant information."**

Dr. Tobias Neuhann, MD, Germany



* Translated from German by OCULUS.

The Register

Automatic measurement activation,
Functions at a glance

Fast Screening Report,
General Overview,
Topography

Belin/Ambrósio Enhanced Ectasia Display,
Keratoconus staging and progression,
Contact Lens Fitting,
Corneal Optical Densitometry,
Fourier Analysis,
Corneal Rings

Cataract Pre-OP Display,
Corneal Power Distribution,
Zernike Analysis,
PNS and 3D Cataract Analysis,
IOL power calculation

Holladay Report,
CSP Report,
3D pIOL Simulation
and Aging Prediction

Software overview,
Networkability

Basic principles

Screening

Refractive

Cataract

More software

Configuration & Tech.

Anterior Segment Tomography

Fast, reproducible, delegable

Thanks to automatic measurement activation the Pentacam® gives you an overall view of the anterior eye segment in two seconds. Measurements are made independent of tear film and examiner. The Pentacam® HR evaluates up to 138,000 measuring points.

The most important functions at a glance:

- Topography of anterior and posterior corneal surface
- Full-surface pachymetry
- Early ectasia detection
- 3D anterior chamber analysis
- Fast Screening Report with data for crucial parameters
- Normative corneal wavefront data
- Total Corneal Refractive Power (TCRP)
- 3D densitometry of the cornea and the crystalline lens
- Contact lens fitting software
- Anterior segment tomography

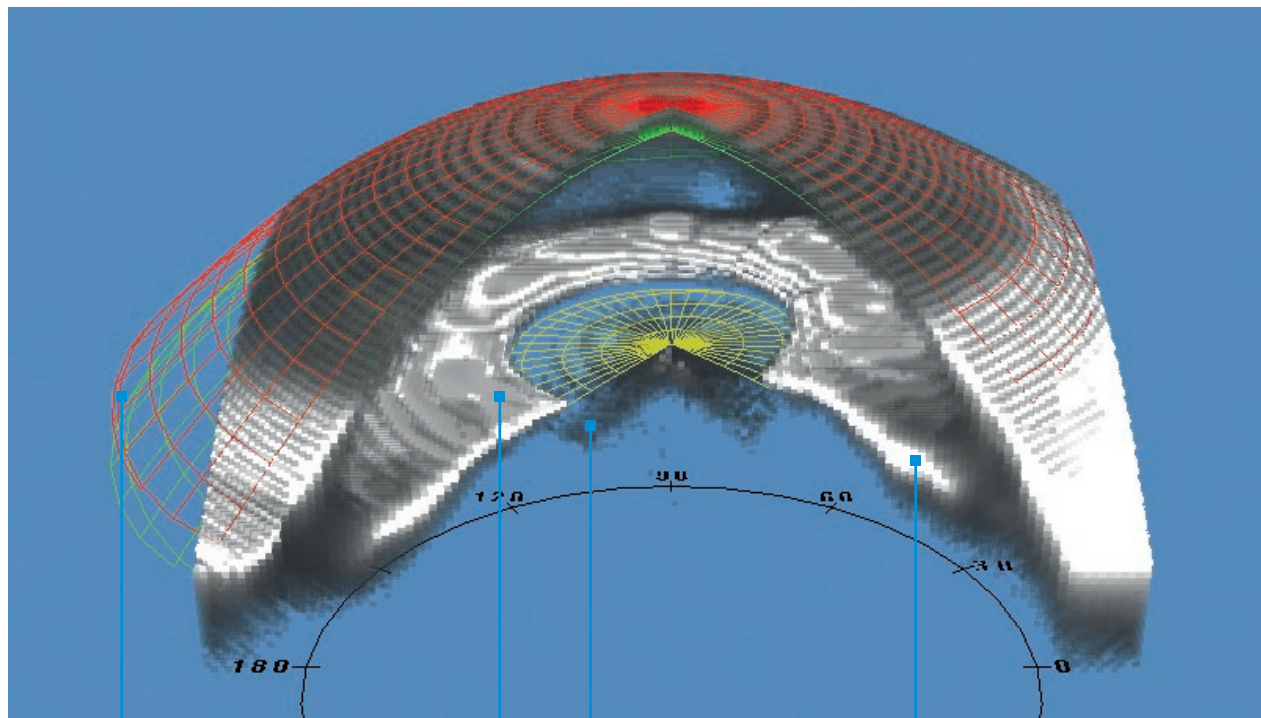

Anterior and posterior
corneal surface

Crystalline lens

Iris

Anterior chamber

The Pentacam®: Indispensable for you and your patients

Before the surgery my doctor explained what the Pentacam® examination involved. I was amazed that I was still even able to see at all with such a clouded lens!



Cataract

Benefit from simple, comprehensive corneal screenings. Fast Screening Report, early detection of ectasia according to Belin/Ambrósio and evaluation of corneal optical densitometry – four clearly defined steps help you select the optimal IOL. The Pentacam® calculates Total Corneal Refractive Power (TCRP), supporting you in particular when it comes to selection, orientation and calculation of toric IOLs. The function for importing axis length from optical biometers and access to ray-tracing programs such as Phaco Optics and OKULIX make it possible to perform IOL calculations on any cornea.

I simply didn't want to wear spectacles anymore! During the pre-op examination the Pentacam® results gave me certainty.



Refractive assessment

The Belin/Ambrósio Enhanced Ectasia Display supports you in early detection of corneal ectasia. A final parameter is calculated and represented in colour. This is how the Pentacam® software assists you in making diagnoses.

Keratometry, asphericity and full-surface pachymetry assist you in planning refractive surgery. The Pentacam® measures irregular corneas with great precision, presenting the necessary parameters in a clear and application-oriented fashion. This ensures reliable planning for implantation of corneal rings, CXL and cornea transplantations.

My risk of developing glaucoma was detected by my ophthalmologist early on. He was able to initiate appropriate measures immediately.



Glaucoma

Glaucoma is one of the most common eye diseases. The Fast Screening Report is a screening tool for detecting it. Make use of the evaluation of anterior chamber angle and volume based on published papers and clinical pictures. In particular, studies* have identified automatically calculated anterior chamber volume as a sensitive parameter.

* Assessment of the anterior chamber parameters after laser iridotomy in primary angle close suspect using Pentacam® and gonioscopy; Alireza et al; Int J Ophthalmol, 2013, 6(5):680-684

Comparison of scheinpflug imaging and spectral domain anterior segment optical coherence tomography for detection of narrow anterior chamber angles; Grewal et al; Eye Vol.: 25

General Screening

Filter, evaluate, represent

The great challenge in clinical routine is filtering, evaluating and representing data in a clear-cut way. This is exactly what the Fast Screening Report does. The crucial data are represented in such a way that you can gain a comprehensive picture of your patient at a glance.

Fast Screening Report

- Data are gathered from published studies and stored in the Pentacam® software.
- The distribution of normal values in a population is represented by the bars shaded in grey.
- The diagrams show the distribution for normal (green) and pathological (red) eyes.
- Sources which the evaluations are based on are cited to provide additional information.
- In cases of irregularities the individual displays for detailed findings appear in the interactive navigation bar.



Early detection of corneal ectasia

Individual patient value

Distribution in normal population

Distribution of a normal (green) and a pathological (red) population

Interactive navigation bar

Screening and follow-up exams ensure safety

After initial information has been provided by the Fast Screening Report additional displays show further, case-specific information. Depending on the irregularities the interactive navigation bar recommends displays which lead you to suitable detailed analyses – custom-tailored to the individual patient.

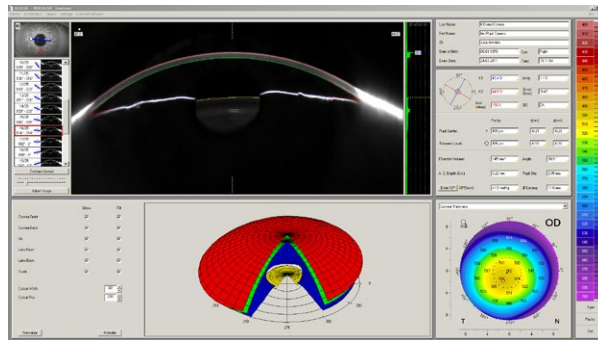

General Overview

The Scheimpflug images allow you to make a qualitative assessment of the anterior eye segment. Opacities of the cornea or the crystalline lens are represented impressively. Keratometry, pachymetry and asphericity allow for an initial analysis of the corneal surface. The anterior chamber is defined by chamber volume, angle and depth. Intraocular pressure is corrected on the basis of central corneal thickness.

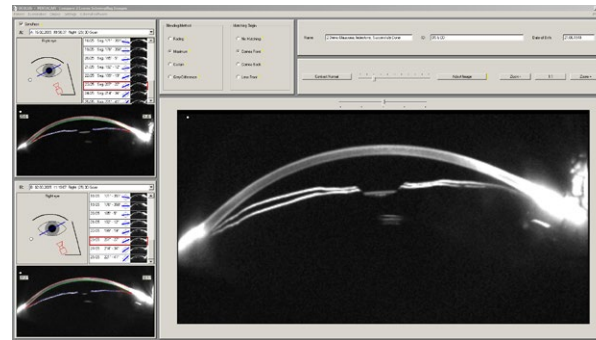

Compare 2 Exams Scheimpflug Images

For better patient consultation you can superimpose 2 Scheimpflug images. This way numerous changes in the anterior eye segment can be detected which you can explain to your patient with the help of visualization.

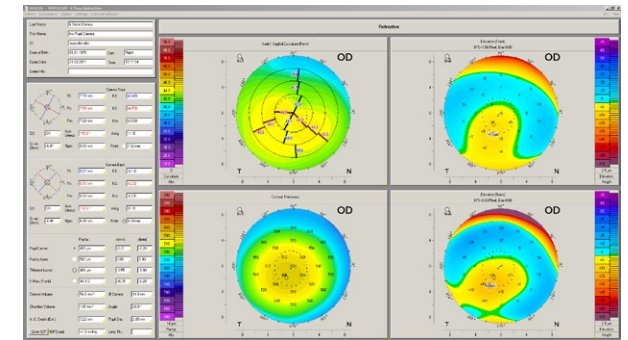

4 Maps Refractive

Topography and elevation maps make quantitative assessments of the corneal surface possible. Especially the posterior elevation map shows pathological changes very early on. The corneal thickness map clearly shows the thinnest position to help you plan refractive surgery, for example.

Combining elevation data of the anterior and posterior corneal surface, topography and pachymetry will help you detect abnormalities early on.

Ectasia Screening

Early ectasia detection

The Pentacam® is equipped with intuitive and user-friendly software features to ensure patient safety and help physicians select the best options for optimal results.

Belin/Ambrósio Enhanced Ectasia Display

In addition to keratoconus detection this screening is geared towards early detection of ectasia. Using this program structural pachymetric progression and the anterior and posterior corneal surface are evaluated. It also has a database for myopic and hyperopic eyes. All the individual parameters are consolidated in one final factor based on regression analysis.

The individual parameters and the final factor are represented in the colours white, yellow and red.

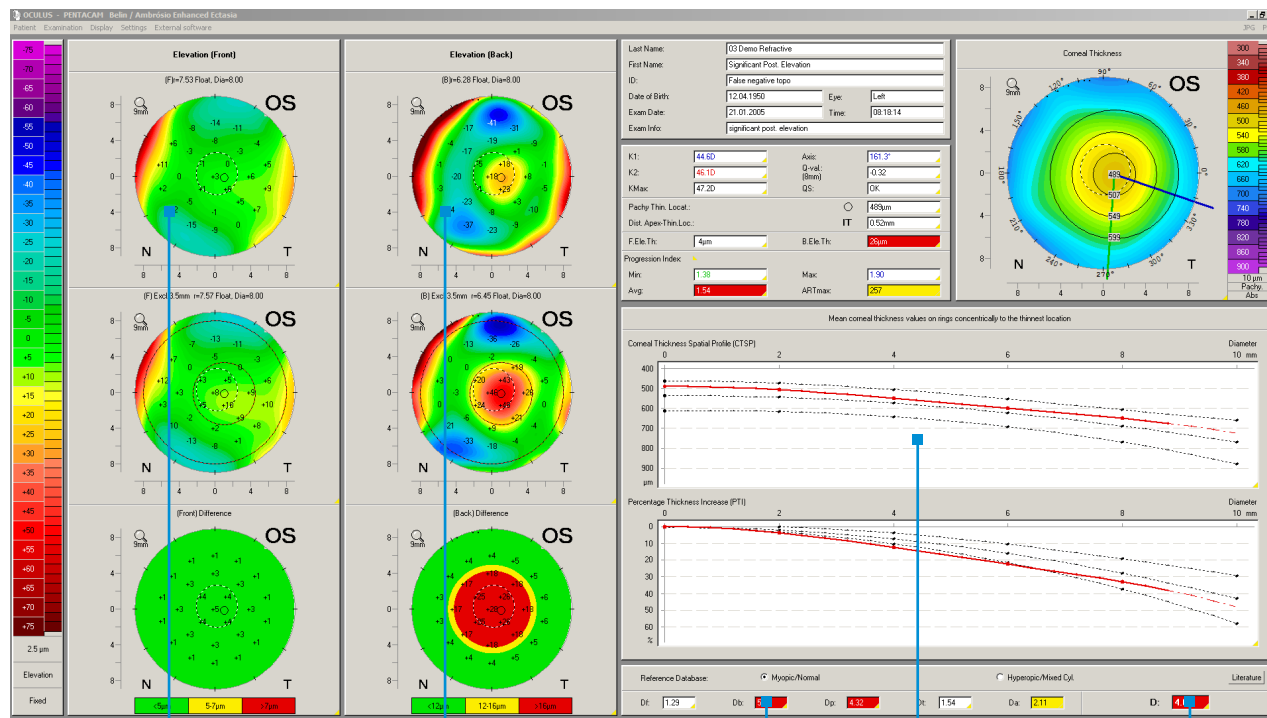

Calculation and analysis of standard and enhanced anterior elevation maps

Calculation and analysis of standard and enhanced posterior elevation maps

Deviation of individual parameters from normal data

Pachymetric progression

Final factor for early detection of corneal ectasia

Keratoconus staging and contact lens fitting

The Pentacam® assists you with state-of-the-art software modules for efficient keratoconus staging and progression based on conclusive measurement results and provides a comprehensive contact lens database.

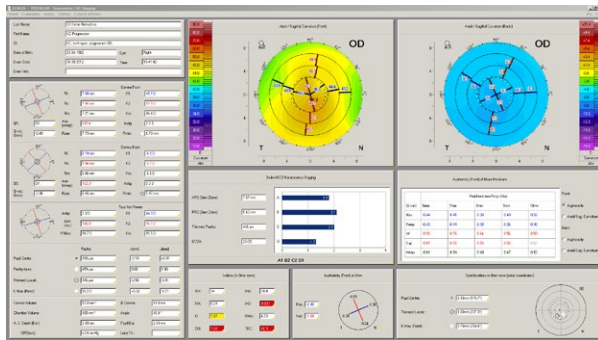

Topometric/KC Staging

The Topometric/KC Staging display is used for keratoconus detection. It contains the Belin ABCD Keratoconus Staging system, a classification method developed by Prof. Michael Belin, USA¹. It shows all parameters relevant to keratoconus classification at a glance, including the posterior corneal surface and the thinnest pachymetric values. This staging system can also be used retrospectively for classification of a patient's earlier examination data.

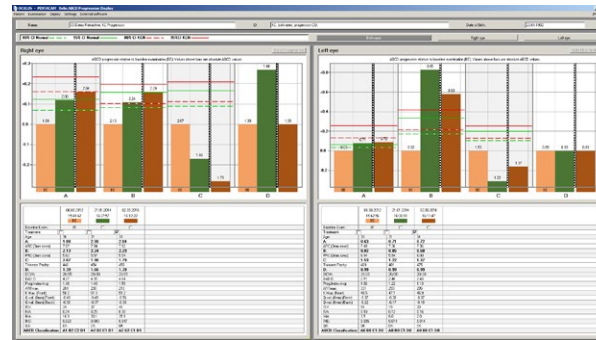

Belin ABCD Progression Display

Keratoconus progression can now be easily detected and depicted with the new Belin ABCD Progression Display, which is based on the Belin ABCD Keratoconus Staging system. Its main benefit is the evaluation of the posterior corneal surface and the cornea's thickness at its thinnest spot. This information is not accessible with Placido topographer and emphasizes the benefit of anterior segment tomographers. Since every single parameter is graded and presented in a diagram, any progression can be easily and quickly detected.

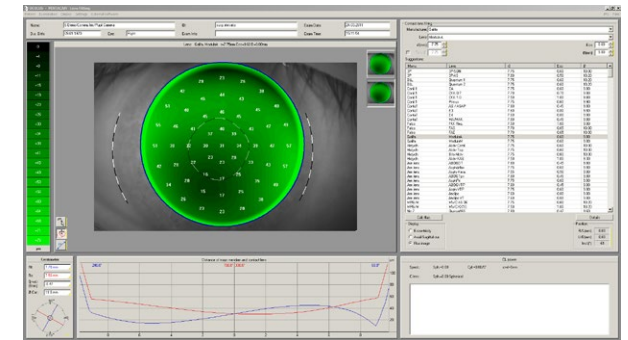

Contact Lens Fitting

Dynamic fluorescein image simulation displays the fit of contact lenses in advance. The integrated expandable contact lens database contains over 840,000 lens geometries. The user can draw up his own rating list and add further contact lenses to the database as required. The inclination and position of the contact lens can be customized manually.

¹ Global consensus on keratoconus and ectatic diseases; Gomes JA1, Tan D, Rapuano CJ, Belin MW, Ambrosio R Jr, Guell JL, Malecaze F, Nishida K, Sangwan VS; Group of Panelists for the Global Delphi Panel of Keratoconus and Ectatic Diseases; Cornea. 2015 Apr; 34(4): 359-69.

Refractive Screening

Planning refractive laser surgery

The Pentacam® measures the entire cornea from limbus to limbus non-invasively. This ingenious method is unaffected by the tear film and guarantees accurate measurements of the corneal centre. It provides a structured representation of all the parameters crucial for planning refractive surgery.

Corneal Optical Densitometry

Panorama images of the cornea make corneal diseases visible. This allows for objective quantification and follow-up. Optical densitometry can be evaluated using a table or a colour chart. In the table the measured values are represented according to various zones and layers. Corneal optical densitometry results are displayed in reference to published age-related normative data. This provides a basis for the detection of other diseases such as Fuchs' Dystrophy.

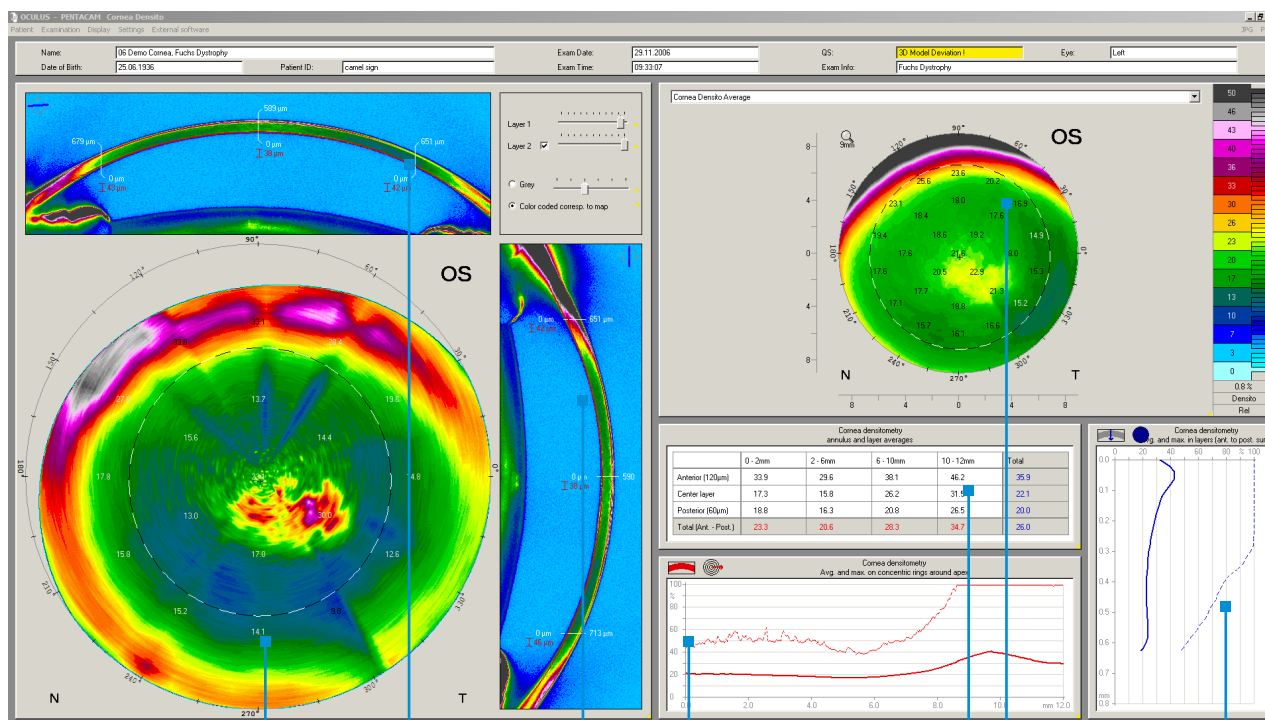

Corneal densitometry of selected layer

Horizontal Scheimpflug image

Graphs for average and maximum densitometry of selected layer

Vertical Scheimpflug image

Average or maximum densitometry map

Densitometry values of different layers and ring segments

Graphs for average and maximum densitometry of selected ring segment

Assess the entire cornea qualitatively and quantitatively

Corneal assessment involves more than mere topography. It rather calls for a holistic evaluation. The Pentacam® represents pachymetric progression, allowing for an evaluation of corneal structure. Optical densitometry facilitates targeted slit lamp examinations that enable you to detect diseases early on.

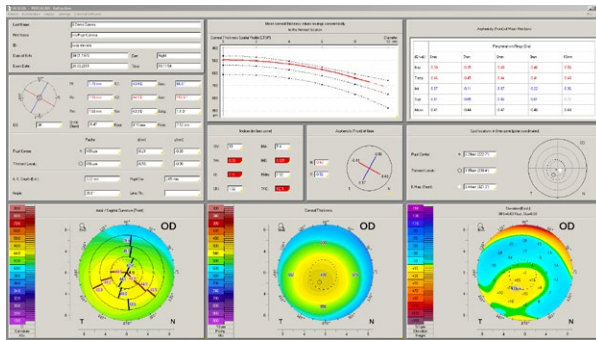

Refractive

The Pentacam® measures the entire cornea from limbus to limbus non-invasively. This ingenious method is unaffected by tear film and it guarantees precise measurements of the corneal centre. You can benefit from the structured representation of all the parameters crucial for planning refractive surgery.

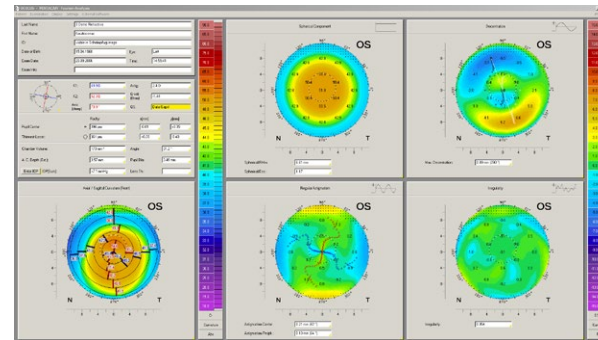

Fourier Analysis

The refractive power of the front surface of the cornea consists of different components. The Fourier Analysis identifies four of them:

- Spherical component
- Decentration
- Regular astigmatism
- Irregularities

Pathological changes can be quantified and possible effects on visual acuity can be explained.

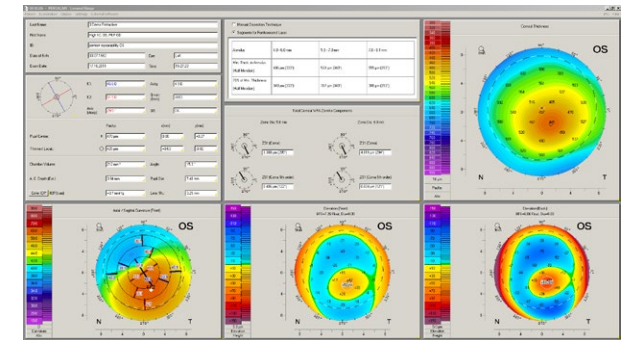

Corneal Rings

This display shows all the parameters necessary for planning corneal ring implantation. Dependent on the selected surgical procedure – manual dissection technique or femtosecond laser – corneal thickness is represented in specific areas and segments.

Cataract Screening

Premium IOL selection in 4 easy steps

Premium IOLs make it possible to improve your patients' visual function considerably. Whether through toric, aspheric or multifocal geometry, the exact measuring data gathered by the Pentacam® will assist you in selecting the right lens.

Cataract Pre-OP Display

The Cataract Pre-OP Display was developed in collaboration with Prof. Dr. Naoyuki Maeda from the University Medical School in Osaka, Japan. This display assists users in selecting the optimal premium IOL.

To do this, the following parameters are taken into consideration:

1. Total corneal higher order aberrations
2. Regularity of corneal topography
3. Total corneal spherical aberrations
4. Comparison of corneal astigmatism

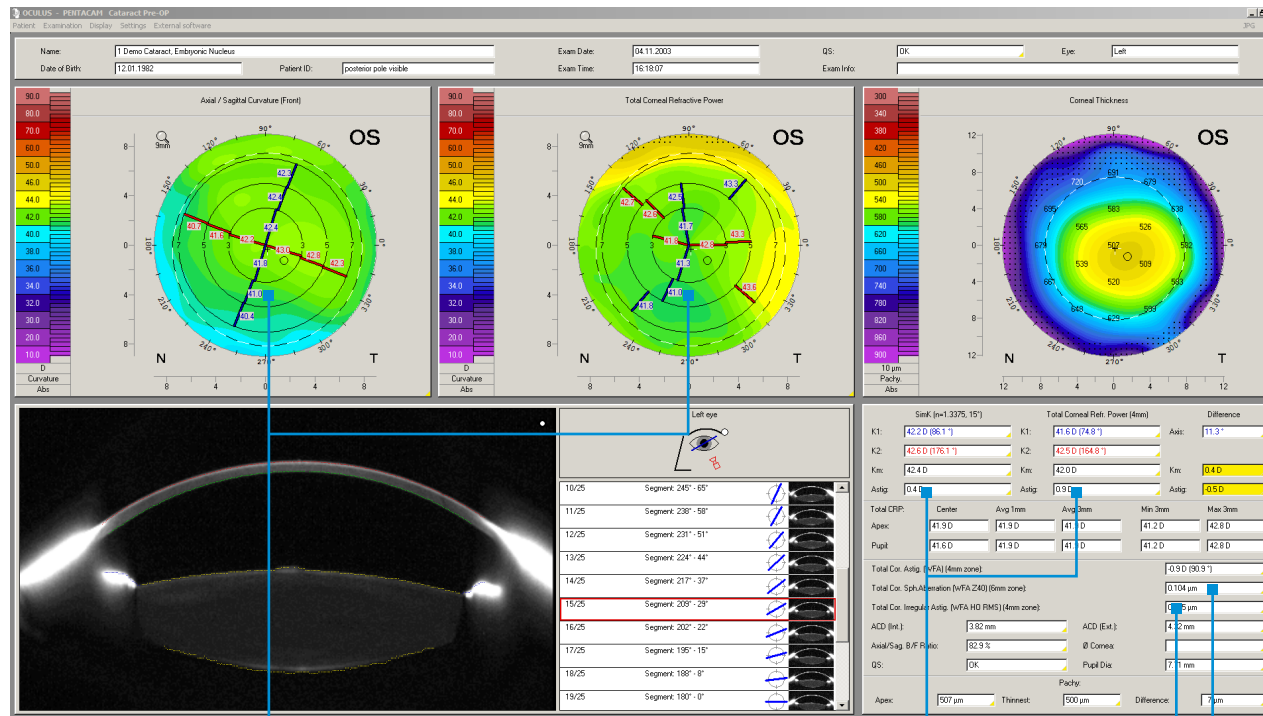

2. Regularity of corneal topography of front surface and Total Cornea Refractive Power – for toric IOL

4. Comparison of corneal astigmatism and influence of the posterior corneal surface – for toric IOL

1. Total corneal higher order aberrations – for multifocal IOL

3. Total corneal spherical aberrations – for spheric or aspheric IOL

Preoperative diagnostics is your success concept

For documentation of cataract progression and optimal surgery planning the Pentacam® provides cataract surgeons with comprehensive analysis options.

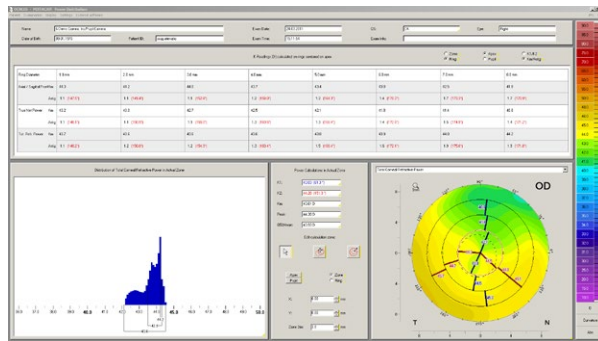

Corneal Power Distribution

The table shows the refractive power of the cornea in various zones and rings. This allows for individual assessment of the posterior corneal surface influence on the total corneal power, astigmatism and axis.

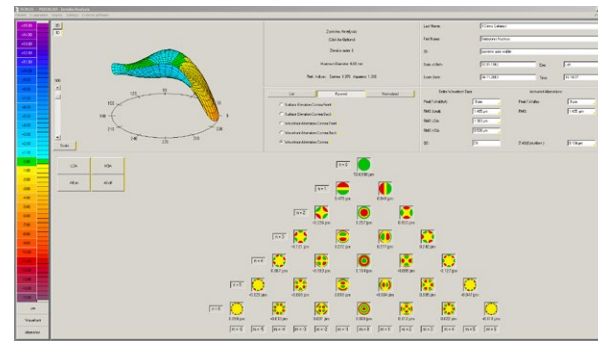

Zernike Analysis

The wavefront error of the cornea as a whole is calculated individually using ray tracing. Higher order aberrations are calculated and represented in comparison to a normal population.

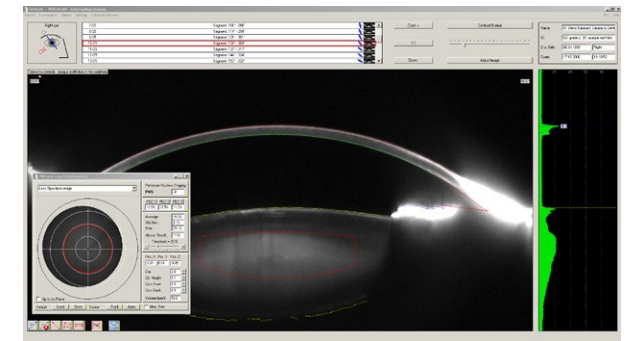

PNS and 3D Cataract Analysis

Through blue-light illumination opacities of the natural lens become visible. Two- and three-dimensional quantification of lens opacification in the individual layers and of posterior capsular opacification is performed. The PNS (Pentacam® Nucleus Staging) function permits optimized ultrasonic energy output in phacoemulsification as well as optimized effective phaco time (EPT) in Femto assisted cataract surgery.

IOL Power Calculation

IOL power calculation for virgin and post corneal refractive eyes

The IOL Calculator provides different formulas for virgin and post corneal refractive eyes. Spheric, aspheric, multifocal and toric IOLs are included in the database. The data of the implanted IOL as well as the post-op refraction can be stored with only two clicks. The software also includes IOL constant optimization (Prof. Wolfgang Haigis).

TCRP for toric IOL power calculation

Toric IOLs can be calculated based on the individual SIA (surgically induced astigmatism) and TCRP. The latter takes the posterior corneal surface into account, improving the accuracy of IOL power calculation¹.

Included formulas: Hoffer Q, Holladay I, SRK/T, Haigis, Savini for toric IOLs¹, HillPotvinShammas² after myopic lasik, HillPotvin after RK³, double K of Hoffer, SRK/T and Holladay, Barrett calculator and the Olsen formula (ray tracing). The Holladay consultant and OKULIX (ray tracing) can be linked to the software.

- 1 An Analysis of the Factors Influencing the Residual Refractive Astigmatism After Cataract Surgery With Toric Intraocular Lenses; Giacomo Savini and Kristian Næser; IOVS2015; 56:827–835.DOI:10.1167/iovs.14-15903
- 2 New algorithm for intraocular lens power calculations after myopic laser in situ keratomileusis based on rotating Scheimpflug camera data; Richard Potvin, OD, Warren Hill, MD; JCRS 2015; 41:339–347 Q 2015 ASCRS and ESCRS
- 3 New algorithm for post-radial keratotomy intraocular lens power calculations based on rotating Scheimpflug camera data; Richard Potvin, OD, Warren Hill, MD; JCRS 2013; 39:358–365 Q 2012 ASCRS and ESCRS

! This software module is available for the Pentacam® HR only

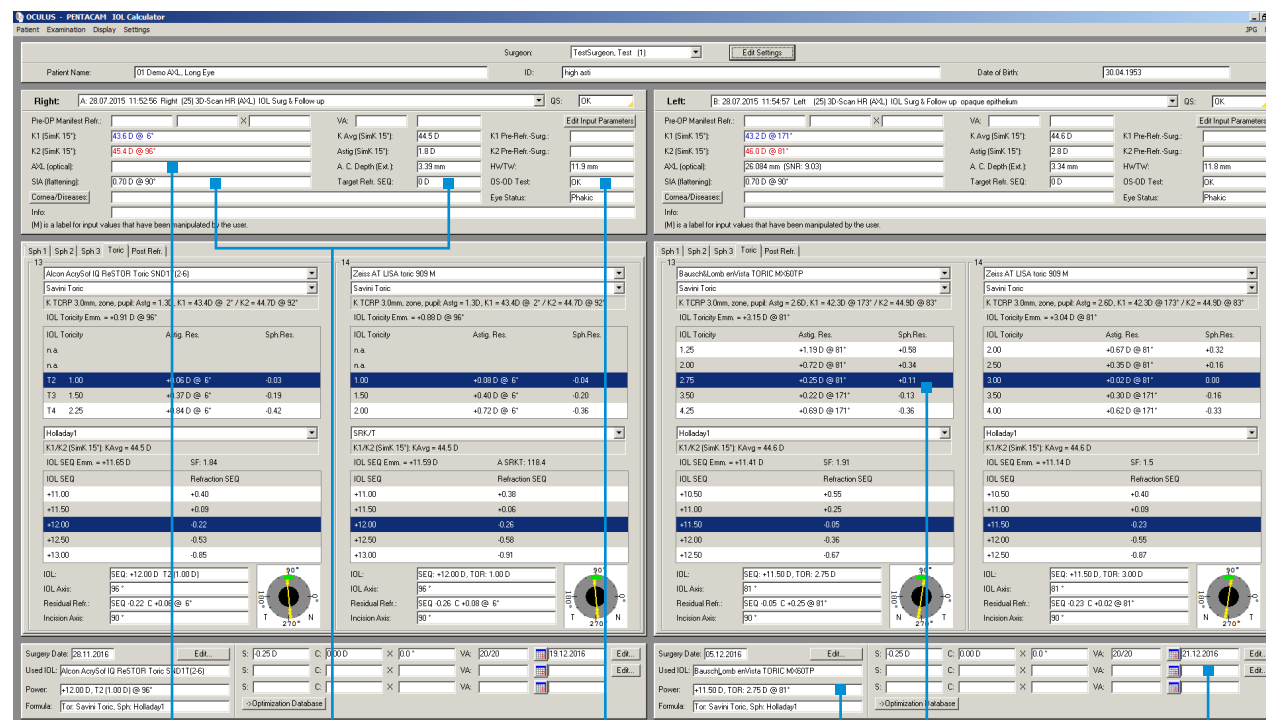

Axial length: to be entered manually

SIA and target refraction SEQ

Automatic plausibility check

Implanted and stored IOL and surgery data

IOL power calculation

Post-op refraction data for IOL constant optimization

IOL power calculation printouts

All necessary information, such as IOL power results and resulting SEQ, is summarized in a clear and intuitive printout, ready for use right before surgery.

IOL printout

For optimal pre-op decision making, all relevant data (i.a. ACD, HWTW) is displayed, the following of which deserve particular mention:

- Chord μ
- Total WFA Z40, 6mm
- Total WFA HOA, 4mm

The result of the automatic plausibility check is displayed, corroborating or querying the measured data to support you in your decision making.

! This software module is available for the Pentacam® HR only

OCULUS pentacam AXL

Patient 01 Demo AXL, Long Eye	Exam Date 28.07.2015
D.o.B. 30.04.1953	Exam Time 11:52:56
ID high asti	Planning Date 20.07.2017
Surgeon TestSurgeon, Test	Eye Status Phakic

Info:

OD (Right)

OS (Left)

QS OK SNR 4.46	Tgt Refr SEQ -0.25 D	SIA 0.25 D @ 180°
AXL (optical) 26.095 mm	SimK 15° (n = 1.3375)	
ACD (Ext.) 3.39 mm	K1 43.6 D / 7.74 mm @ 6°	
Pupil Dia 5.50 mm	K2 45.4 D / 7.43 mm @ 96°	
HWTW 11.9 mm	K Avg 44.5 D / 7.58 mm	
Chord μ 0.23 mm @ -57°	Astig 1.8 D	
Total WFAZ40, 6mm 0.335 μ m	K1 Pre-Refr.-Surg.	
Total WFAHOA, 4mm 0.239 μ m	K2 Pre-Refr.-Surg.	
OS-OD Test OK		

1 Alcon AcrySof IQ ReSTOR SN6AD1

Haigis

K1/K2 (SimK 15°): KAvg = 44.5 D (nRef=1.3375)

IOL SEQ Emm. = +11.71 D | a0: -0.385 a1: 0.197 a2: 0.204

IOL SEQ	Refraction SEQ
+11.50	+0.14
+12.00	-0.20
+12.50	-0.53
+13.00	-0.88
+13.50	-1.22

2 Alcon AcrySof IQ ReSTOR SN6AD1

SRK/T

K1/K2 (SimK 15°): KAvg = 44.5 D

IOL SEQ Emm. = +11.96 D ASRKT: 119

IOL SEQ	Refraction SEQ
+11.50	+0.28
+12.00	-0.02
+12.50	-0.33
+13.00	-0.65
+13.50	-0.97

3 AMO SENsAR® 3-Piece IOL AR40

Haigis

K1/K2 (SimK 15°): KAvg = 44.5 D (nRef=1.3375)

IOL SEQ Emm. = +11.73 D | a0: -2.42 a1: 0.157 a2: 0.288

IOL SEQ	Refraction SEQ
+11.00	+0.48
+12.00	-0.18
+12.50	-0.52
+13.00	-0.86
+13.50	-1.20

4 AMO SENsAR® 3-Piece IOL AR40

SRK/T

K1/K2 (SimK 15°): KAvg = 44.5 D

IOL SEQ Emm. = +11.75 D ASRKT: 118.7

IOL SEQ	Refraction SEQ
+11.00	+0.47
+12.00	-0.15
+12.50	-0.47
+13.00	-0.79
+13.50	-1.11

Printout of an IOL power calculation for a multifocal IOL

OCULUS pentacam AXL

Patient 01 Demo AXL, Long Eye	Exam Date 28.07.2015
D.o.B. 30.04.1953	Exam Time 11:54:57
ID high asti	Planning Date 20.07.2017
Surgeon TestSurgeon, Test	Eye Status Phakic

Info:

incision

OS (Left)

QS OK SNR 9.03	Tgt Refr SEQ -0.25 D	SIA 0.25 D @ 0°
AXL (optical) 26.084 mm	SimK 15° (n = 1.3375)	
ACD (Ext.) 3.34 mm	K1 43.2 D / 7.81 mm @ 171°	TCRP 4mm, zone, pup. 42.3 D @ 173°
Pupil Dia 4.43 mm	K2 46.0 D / 7.34 mm @ 81°	44.9 D @ 83°
HWTW 11.8 mm	K Avg 44.6 D / 7.57 mm	43.6 D
Chord μ 0.13 mm @ -57°	Astig 2.8 D	2.6 D
Total WFAZ40, 6mm 0.524 μ m	K1 Pre-Refr.-Surg.	
Total WFAHOA, 4mm 0.288 μ m	K2 Pre-Refr.-Surg.	
OS-OD Test OK		

13 Zeiss AT TORBI 709 MP

SRK/T

K1/K2 (SimK 15°): KAvg = 44.6 D

IOL SEQ Emm. = +11.53 D ASRKT: 118.5

Savini Toric

K TCRP 3.0mm, Zone, Pupillic -Astig = 2.6D @ 83°

IOL Toricity Emm. = +4.36 D @ 84°

IOL SEQ	Refraction SEQ	IOL Toricity	Astig. Res.
+11.00	+0.33	3.00	+0.89 D @ 84°
+11.50	+0.02	3.50	+0.56 D @ 84°
+12.00	-0.30	4.00	+0.24 D @ 84°
+12.50	-0.62	n.a.	
+13.00	-0.94	n.a.	

IOL	SEQ: +12.00 D, TOR: 4.00 D
IOL Axis	84°
Residual Refr.	SEQ -0.30 C +0.24 @ 84°
Incision Axis	0°

Printout of an IOL power calculation for a toric IOL

More Software Modules

Various software options for different challenges

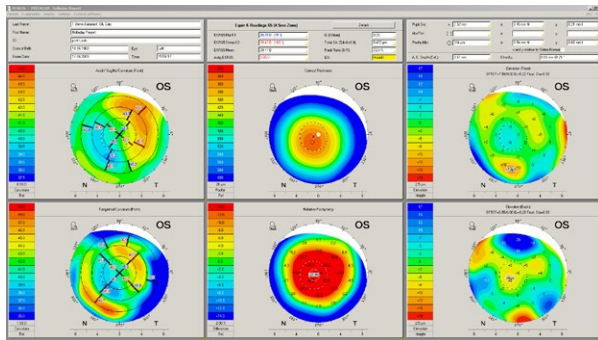

Holladay Report

The Holladay Report was developed in collaboration with Jack T. Holladay, M.D., USA. This report supplies data for calculating IOL refractive power in patients who have undergone LASIK, PRK or RK. The advantage lies in the fact that no preoperative data must be supplied for this. The refractive power of the entire cornea is calculated and described in terms of various zones through EKR's (Equivalent Keratometer Readings). These can be entered into the Holladay II IOL calculation formula, for example.

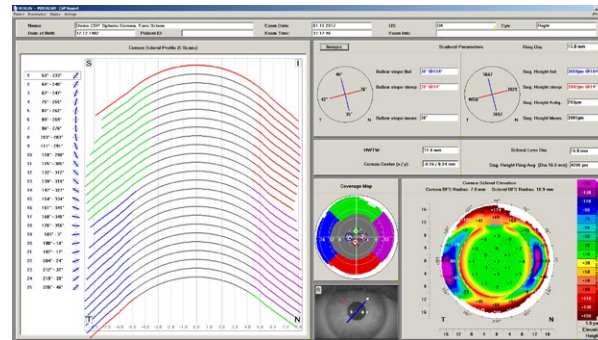

CSP Report

With the CSP Report, the Pentacam® now measures sagittal height, a parameter needed for scleral lens fitting. 250 Scheimpflug images covering a diameter of up to 18 mm are taken in the measuring process. All images of a Cornea Scleral Profile (CSP) scan are taken from the same visual axis without the need for eye movement. The usual Pentacam® data are recorded as well and populated into the displays already familiar to Pentacam® users. The CSP scan is a tear film independent measurement with automatic release. This means that the values from the CSP Report are as reproducible as all other data measured with the Pentacam®. A link to external fitting software for scleral lenses is available.

! This software module is available for the Pentacam® only

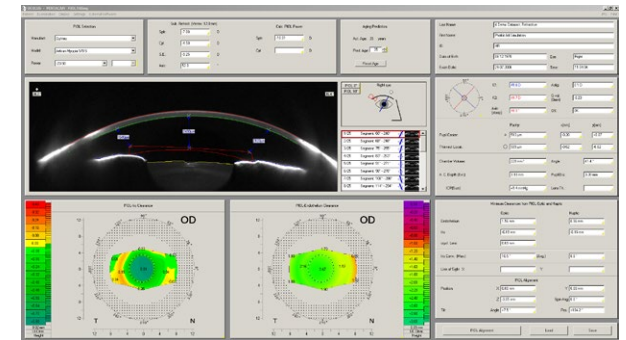

3D pIOL Simulation and Aging Prediction

This software module assists you in preoperative planning of iris-fixated phakic IOLs. After the subjective refraction is entered the software calculates the necessary pIOL refractive power dependent on the selected pIOL type. The position of the pIOL in the anterior chamber is automatically calculated in 3D and represented in the Scheimpflug images. The minimal distances between the pIOL and the crystalline lens as well as the endothelium are calculated automatically in 3D and displayed numerically as well as in a color map.

! This software module is available for the Pentacam® HR only

All Features at a Glance

Customize the OCULUS Pentacam®/Pentacam® HR to your own requirement

Software included

General Overview
Fast Screening Report
Topometric/KC-Staging (Belin ABCD Keratoconus Staging)
Belin ABCD Progression Display
Topography maps of the anterior and posterior corneal surface
Pachymetry map
4 Maps Refractive
Iris Image and HWTW
Compare 2 Exams
Tomography
Scheimpflug Image Overview
Belin/Ambrósio Enhanced Ectasia Display
Contact Lens Fitting

Additional software

Holladay Report	P	HR
CSP Report	P	HR
3D pIOL Simulation and Aging Prediction	P	HR
IOL Calculator	P	HR

P Available for Pentacam®

HR Available for Pentacam® HR

Optional examination functions

Cataract Software Package

- Cataract Pre-OP Display
- Corneal Power Distribution
- Zernike Analysis with normative corneal wavefront
- PNS and 3D Cataract Analysis
- Total Corneal Refractive Power (TCRP)
- Automatic calculation of the anterior chamber angle in 360°, measurement based on Scheimpflug images
- 4 Maps Topometric and 4 Maps Chamber
- Show 2 Exams
- Compare 4 Exams

Refractive Software Package

- Corneal Optical Densitometry
- Corneal Rings
- Fourier Analysis
- Refractive
- Pachymetric
- 4 Maps Selectable
- Show 2 Exams
- Compare 4 Exams

Optional evaluation functions

DICOM Interface

Basic principles

Screening

Refractive

Cataract

More software

Configuration & Tech.

Scheimpflug Images

Impressive, convincing, simply sharp

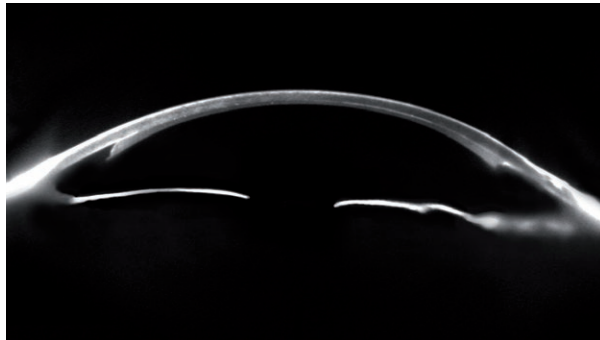

Descemet Stripping After Endothelium Keratoplasty (DSAEK)



Extremely thin keratoconus cornea



Penetrating Keratoplasty (PKP)



Implantable Collamer® Lens (ICL)

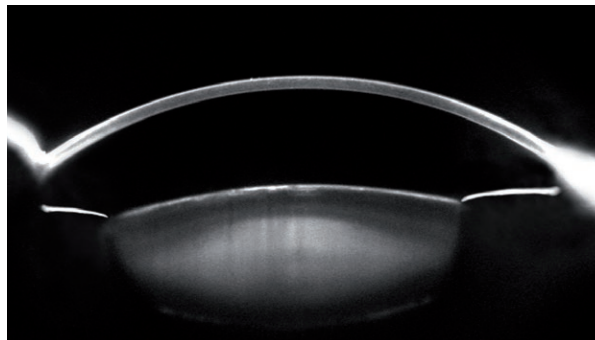

Nuclear sclerosis



Narrow (anterior) chamber angle

The Fascination of Technology

Ingenious yet simple

The Floating License Key – for maximum flexibility

This basic Pentacam® software is already available at all workplaces in your network. You decide which optional examination and evaluation functions you need in addition. You also choose the number of optional evaluation software features which should be available simultaneously. The Floating License Key (FLK) activates the corresponding licenses and makes them available on your network. To help you decide what you need all the optional evaluation functions can be accessed 20 times for demonstration purposes.

Efficiency and productivity through networking

The OCULUS Patient Data Management system (PDM) optimises your work processes. It is always included in the scope of delivery; it organises patient and examination data from all OCULUS instruments. The PDM is network-compatible and can be incorporated into many Electronic Medical Record (EMR) systems. Needless to say, the OCULUS PDM communicates with the DICOM environment and makes results available in DICOM format.

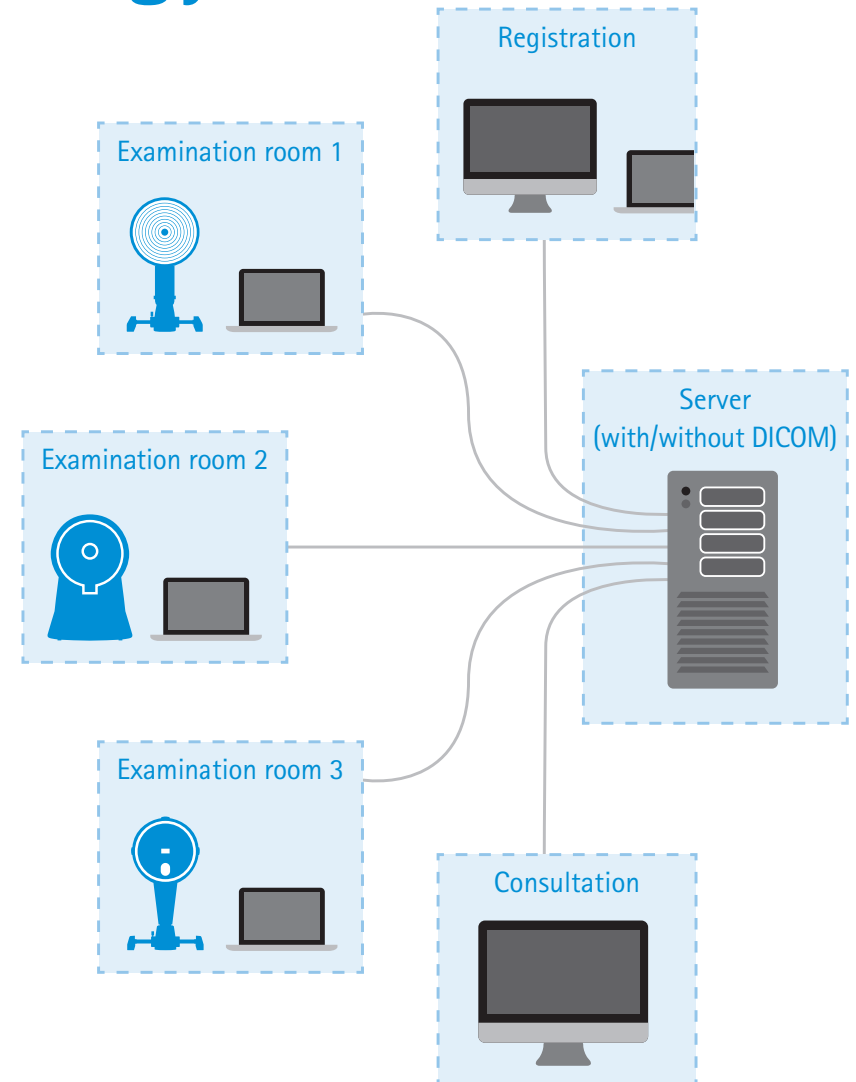

Technical Data

Pentacam®/Pentacam® HR

Scheimpflug camera	Pentacam®	Pentacam® HR
Camera	digital CCD camera	digital CCD camera
Light source	blue LED (475 nm UV-free)	blue LED (475 nm UV-free)
Processor	DSP with 400m operations/s	DSP with 400m operations/s
Speed	50 images in 2 seconds ¹⁾	100 images in 2 seconds ²⁾
Measurement range	Pentacam®	Pentacam® HR
Curvature	3 - 38 mm 9 - 99 D	3 - 38 mm 9 - 99 D
Precision	± 0.2 D	± 0.1 D
Reproducibility	± 0.2 D	± 0.1 D
Operating distance	80 mm (3.1 in)	80 mm (3.1 in)
Technical specifications	Pentacam®	Pentacam® HR
Dimensions (W x D x H)	275 x 320 - 400 x 500 - 530 mm (10.8 x 12.6 - 15.7 x 19.7 - 20.9 in)	275 x 320 - 400 x 500 - 530 mm (10.8 x 12.6 - 15.7 x 19.7 - 20.9 in)
Weight	10.1 kg (22.3 lbs)	10.6 kg (23.4 lbs)
Max. power consumption	35 W	42 W
Recommended computer specifications	CPU Intel Core i5-6600, HDD 1 TB, RAM 8 GB, MS Windows® 10 Pro, VESA, USB interface	CPU Intel Core i5-6600, HDD 1 TB, RAM 8 GB, MS Windows® 10 Pro, VESA, USB interface

¹⁾ Scheimpflug image of the entire anterior segment

²⁾ Cornea fine scan

CE in accordance with Medical Device Directive 93/42/EEC

WWW.OCULUS.DE



OCULUS is certified by TÜV according to
DIN EN ISO 13485

OCULUS Optikgeräte GmbH

Postfach • 35549 Wetzlar • GERMANY
Tel. +49 641 2005-0 • Fax +49 641 2005-295
Email: export@oculus.de • www.oculus.de

- OCULUS USA, sales@oculususa.com
- OCULUS Canada, sales@oculus.ca
- OCULUS Asia, info@oculus.hk
- OCULUS Iberia, info@oculus.es
- OCULUS Turkey, info@oculus-turkey.com.tr
- OCULUS Czechia, oculus@oculus.cz

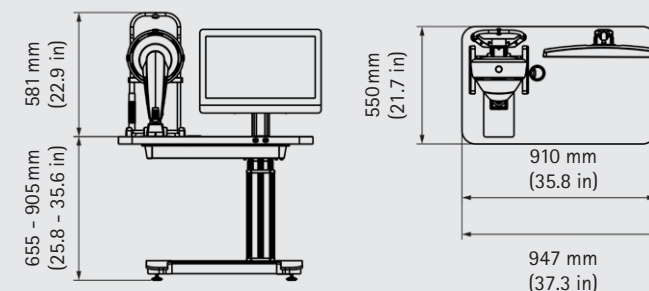
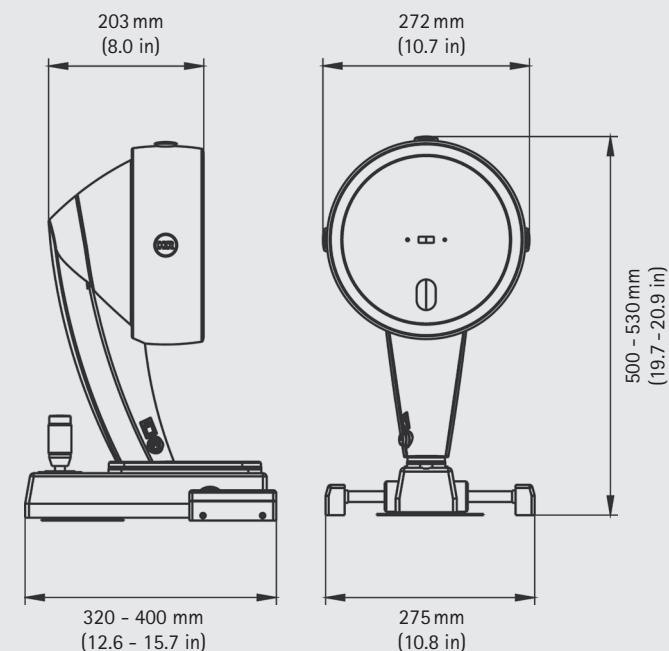

The availability of products and features may vary by country. OCULUS reserves the right to change product specifications and design. All information is valid at the time of printing (04/18)



30/0418/EN/HA
P/70700/EN